

EN

**DETAILED
INSTRUCTIONS**
OF THE ELECTRIC
PYROLYTIC OVEN

gorenje

BY

STARCK®

We thank you for your trust and the purchase of our appliance.

This detailed instruction manual is supplied to make the use of this product easier. The instructions should allow you to learn about your new appliance as quickly as possible.

Make sure you have received an undamaged appliance. If you do find transport damage, please contact the seller from which you purchased the appliance, or the regional warehouse from which it was supplied. The telephone number can be found on the invoice or on the delivery note.

Instructions for installation and connection are supplied on a separate sheet.

Instructions for use are also available at our website:

www.gorenje.com / < <http://www.gorenje.com> />



Important information



Tip, note

CONTENTS

4 THE ELECTRIC PYROLYTIC OVEN 7 Technical specifications 8 Control unit	INTRODUCTION
10 IMPORTANT SAFETY INSTRUCTIONS 12 Before connecting the oven:	
13 BEFORE USING THE APPLIANCE FOR THE FIRST TIME	PREPARING THE APPLIANCE FOR THE FIRST USE
14 SWITCHING ON THE APPLIANCE FOR THE FIRST TIME 14 Setting the clock	
15 STEPS OF THE COOKING PROCESS (1-6) 15 Step 1: CHOOSING THE COOKING SYSTEM 17 Step 2: CHOOSING THE SETTINGS 18 Step 3: TIMER FUNCTIONS 20 Step 4: SSELECTING ADDITIONAL FUNCTIONS 22 Step 5: START THE COOKING PROCESS 22 Step 6: END THE COOKING PROCESS AND SWITCHING OFF THE OVEN	COOKING STEPS
23 DESCRIPTIONS OF SYSTEMS (COOKING MODES) AND COOKING TABLES	
40 MAINTENANCE & CLEANING 41 Conventional oven cleaning 42 Automatic oven cleaning - pyrolysis 44 Removing and cleaning the wire guides 45 Removing and inserting the oven door 47 Removing and inserting the oven door glass pane 48 Replacing the bulb	MAINTENANCE & CLEANING
49 TROUBLESHOOTING TABLE	TROUBLE-SHOOTING
50 DISPOSAL	
51 COOKING TEST	OTHER

THE ELECTRIC PYROLYTIC OVEN

(DESCRIPTION OF THE OVEN AND EQUIPMENT - DEPENDING ON THE MODEL)

The figure represents one of the built-in appliance models. Since the appliances for which these instructions were drawn up may have different equipment, some functions or equipment may be described in the manual that may not be present in your appliances.

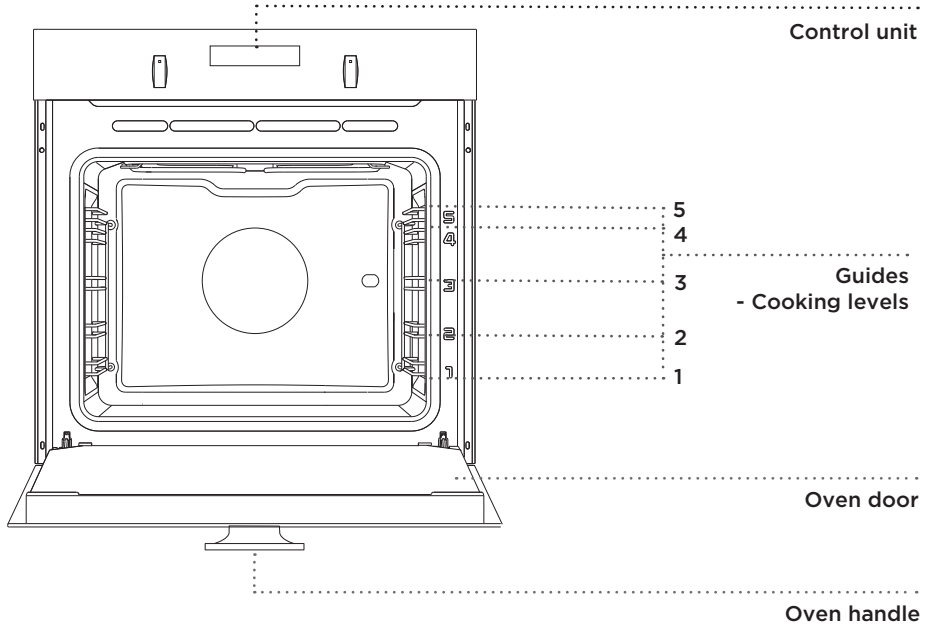

WIRE GUIDES

The wire guides allow preparation of the food on 5 levels (please note that the levels/guides are counted from the bottom up).

Guides 4 and 5 are intended for grilling.

TELESCOPIC PULL-OUT GUIDES

Telescopic pull-out (extendible) guides may be fitted for the second, third, and fourth level.

Pull-out guides can be partly or fully extendible.

OVEN DOOR SWITCH

The switches deactivate oven heating and the fan when the oven door is opened during the cooking process. When the door is closed, the switches turn the heaters back on.

COOLING FAN

The appliance is fitted with a cooling fan that cools the housing and the appliance control panel.

EXTENDED OPERATION OF THE COOLING FAN

After the oven is switched off, the cooling fan continues to operate for a short while in order to cool the oven. (Extended cooling fan operation depends on the temperature in the center of the oven).

OVEN EQUIPMENT AND ACCESSORIES



Before pyrolytic cleaning, remove all accessories from the oven.

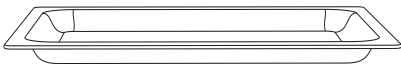

GLASS BAKING DISH is used for cooking with all oven systems. It can also be used as a serving tray.



The **GRID** is used for grilling or as support for a pan, baking tray or baking dish with the food.



There is a safety latch on the grid. Therefore, lift the grid slightly at the front when pulling it out from the oven.

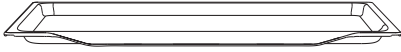

The **SHALLOW BAKING SHEET** is used for baking pastry and cakes.

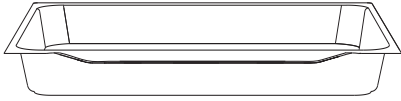

The **DEEP BAKING TRAY** is used for roasting meat and baking moist pastry. It can also be used as a drip tray.

 Never place the deep baking tray in the first guide during the cooking process, except when grilling food or using the roasting spit and you are only using the deep tray as a drip tray.

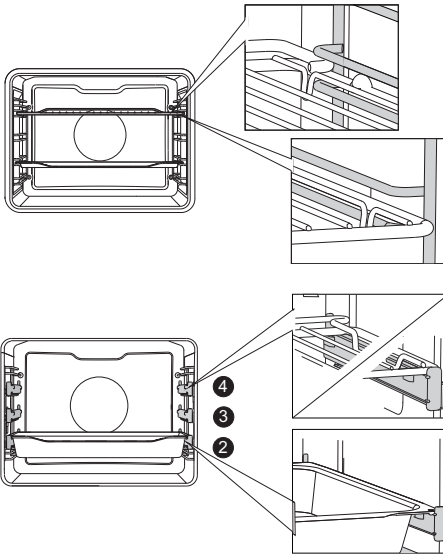

The grid or the tray should always be inserted into the groove between the two wire profiles.

With telescopic extendible guides, first pull out the guides of one level and place the grid or the baking tray onto them. Then, push them in with your hand as far as they will go.

 Close the oven door when the telescopic guides are retracted all the way into the oven.



The appliance and some of the accessible parts tend to heat up during cooking. Use oven mitts.

TECHNICAL SPECIFICATIONS

(DEPENDING ON THE MODEL)

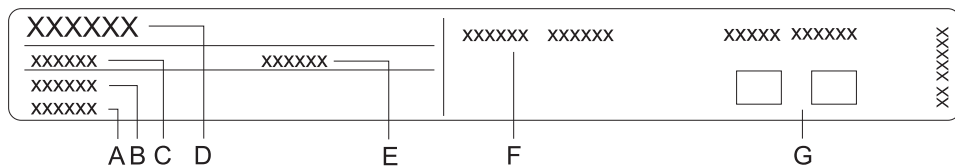

- A Serial number
- B Code/ID
- C Type
- D Brand
- E Model
- F Technical data
- G Compliance symbols

The rating plate indicating the basic information about the appliance is located at the edge of the oven and it is visible when the oven door is opened.

CONTROL UNIT

(DEPENDENT ON THE MODEL)

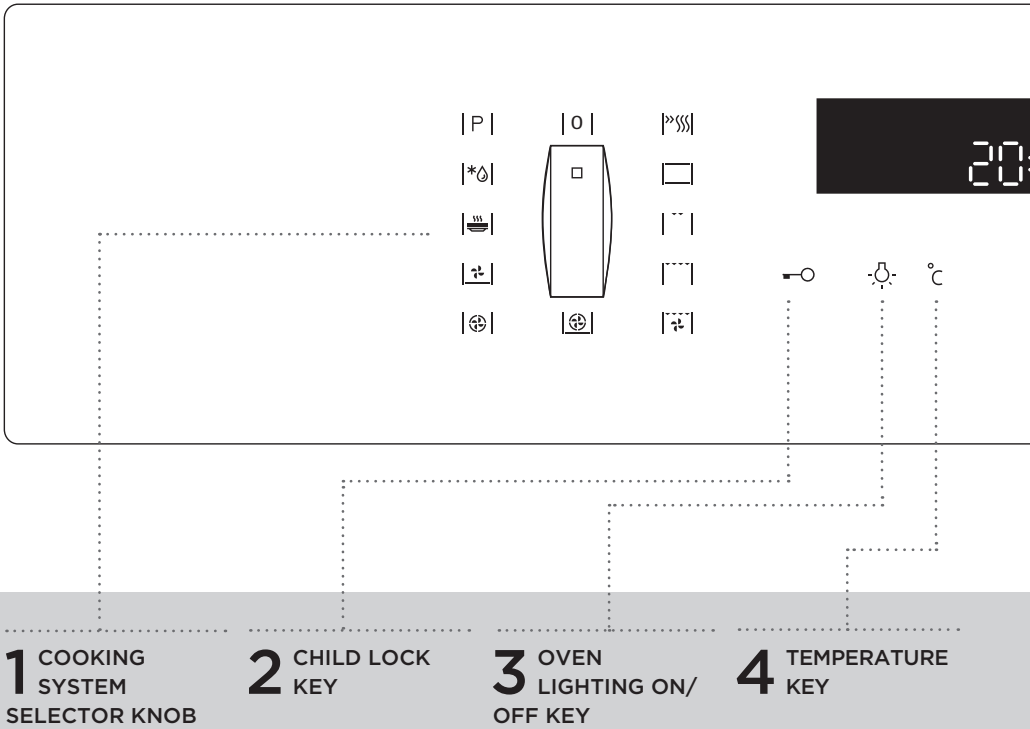

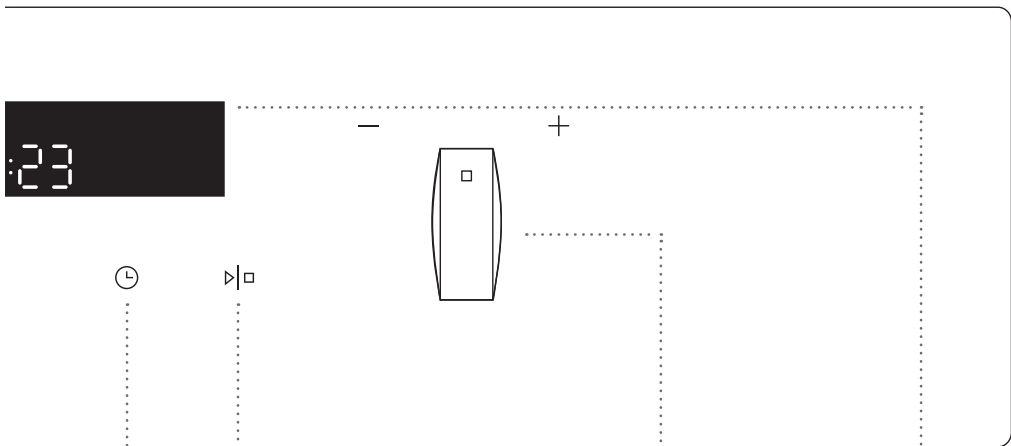

5 ELECTRONIC TIMER KEY

Cooking duration

End of cooking

Alarm

Clock

6 START/STOP KEY

Use this key to
**start or stop the
program.**

7 SETTINGS KNOB (-/+)

Use this knob to
set the time and
temperature.

8 COOKING INFORMATION AND CLOCK DISPLAY

NOTE:

The keys will respond better if you touch them with a larger area of your fingertip. Each time you press a key, a short acoustic signal will be sounded.

IMPORTANT SAFETY INSTRUCTIONS



CAREFULLY READ THE INSTRUCTIONS AND SAVE THEM FOR FUTURE REFERENCE.

This appliance may only be used by children aged 8 years and above and persons with reduced physical, sensory or mental capabilities or lack of experience and knowledge if supervision or instructions are provided to them concerning use of the appliance in a safe way and if they understand the hazards involved. Do not let the children play with the appliance. Cleaning and user maintenance shall not be made by children without supervision.

WARNING: The appliance and some of its accessible parts may become very hot during use. Be careful not to touch the heaters. Children younger than 8 years should be constantly supervised.

The appliance becomes very hot during use. Be careful not to touch the oven heaters.

WARNING: The accessible parts of the appliance may become hot during use. Children should be kept away from the oven.

Only use the temperature probe recommended for use in this oven.

WARNING: Before replacing the light bulb, make sure the appliance has been disconnected from the power mains, in order to prevent the hazard of an electric shock.

Do not use abrasive cleaners or sharp metal scrapers to clean the oven as they may damage the finish or the protective enamel coating. Such damages may lead to cracking of the glass.

Do not use steam cleaners or high pressure cleaners to clean the appliance as this may result in an electric shock.

The appliance is not intended to be controlled with external timers or special control systems.

The appliance is intended for household use. Do not use it for any other purpose, such as room heating, drying of pets or other animals, paper, fabrics, herbs etc. as this may lead to injury or fire hazard.

The appliance may only be connected to the power mains by an authorized service technician or expert.

Tampering with the appliance or nonprofessional repair thereof may result in risk of severe injury or damage to the product.

If the power cords of other appliances located near this appliance are caught in the oven door, they may be damaged, which may in turn result in a short circuit. Therefore, keep the power cords of other appliances at a safe distance.

If the power cord is damaged, it should be replaced by the manufacturer or an authorized service technician, in order to avoid hazard.

Do not line the oven walls with aluminium foil and do not place baking trays or other cookware on the oven bottom. Aluminium foil would prevent air circulation in the oven, hinder the cooking process, and ruin the enamel coating.

Oven door become very hot during operation. A third glass is installed for extra protection, reducing the temperature of the outside surface (only with some models).

Oven door hinges may be damaged when under excessive load. Do not place heavy pans on open oven door and do not lean against open oven door when cleaning the oven cavity. Never stand on the open oven door and do not let children to sit on it.

Make sure the vents are never covered or obstructed in any other way.

Safe use of the oven during pyrolytic cleaning

Before activating the automatic cleaning process, remove the grid, the spit roasting kit, glass baking trays, meat probe, and any other cookware that is not a part of oven equipment.

During the automatic cleaning process, the oven gets very hot from the outside. Risk of burns! Keep children away from the oven.

Before activating the automatic cleaning process, carefully read and follow the instructions in the chapter Cleaning and Maintenance where correct and safe use of this function is described.

Do not place anything directly onto the oven cavity bottom.

Pieces of food, grease, and roast juice may ignite during the automatic pyrolytic cleaning process.

Danger of fire! Remove larger food residues and other impurities from the oven each time before the automatic cleaning process.

Do not attempt to open the oven door while the automatic pyrolytic cleaning process is in progress.

Make sure no impurities enter the door guide lock opening, which could prevent automatic locking of oven door during the automatic cleaning procedure.

In case of a power outage during the pyrolytic cleaning process, the program is terminated after two minutes and the oven door remains locked. The door will be unlocked approximately 30 minutes after power supply is restored, regardless of whether the appliance has cooled down in the meantime.

Do not touch any metal part of the appliance during the automatic cleaning process!

As a result of the automatic cleaning, the oven cavity and oven equipment cleaned in such way may discolour and lose some shine.

BEFORE CONNECTING THE OVEN:



Carefully read the instructions for use before connecting the appliance. Repair or any warranty claim resulting from incorrect connection or use of the appliance shall not be covered by the warranty.

BEFORE USING THE APPLIANCE FOR THE FIRST TIME

Upon receiving the appliance, remove all parts, including any transport equipment, from the oven.

Clean all accessories and utensils with warm water and regular detergent. Do not use any abrasive cleaners.

Before using the oven for the first time, heat it with the upper and lower heater system at 200 °C for approximately one hour. The characteristic "new appliance" scent will be released; make sure the room is well ventilated.

SWITCHING ON THE APPLIANCE FOR THE FIRST TIME

SETTING THE CLOCK

After connecting your appliance or after an extended power outage, 12:00 will flash on the display and the symbol will light up. Set the time of day.

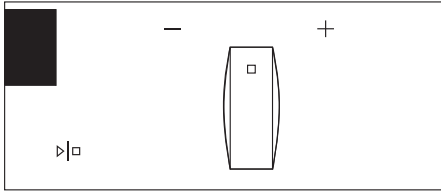

1 Rotate the SETTINGS KNOB (-/+) and first set the minutes; then, the cursor will switch to hours. After three seconds, the settings will be saved.

 Turning the knob farther to the right or to the left will change the settings more quickly.



2 Confirm by pressing START/ STOP. If nothing is pressed within the next three seconds, the setting will be stored automatically.

 The oven will also work if the clock is not set. However, timer functions are not available in this case (see chapter SETTING THE TIMER FUNCTIONS).

After a few minutes of idling, the appliance will switch to standby mode.

CHANGING THE CLOCK SETTING

Clock settings may be changed when no timer function is activated. Press the key to  set the current time. Confirm by pressing START/ STOP.







STEPS OF THE COOKING PROCESS (1-6)

STEP 1: CHOOSING THE COOKING SYSTEM

Rotate the knob (left and right) to select 0 COOKING SYSTEM (see program table). The selected icon will appear on the display.

Settings can also be changed during operation.

SYSTEM	SYSTEM	SUGGESTED TEMPERATURE °C
COOKING SYSTEMS		
	RAPID PREHEAT Use this function if you wish to heat the oven to the desired temperature as quickly as possible. This function is not appropriate for cooking food. When the oven heats up to the desired temperature, the heating process is completed.	160
	UPPER AND BOTTOM HEATER The heaters in the bottom and in the ceiling of the oven cavity will radiate heat evenly into the oven interior. Pastry or meat can only be baked/roasted at a single height level.	200
	GRILL Only grill heater, a part of the large grill set, will operate. This system is used for grilling a smaller amount of open sandwiches or beer sausages, and for toasting bread.	240
	LARGE GRILL The upper heater and the grill heater will operate. The heat is radiated directly by the grill heater installed in the oven ceiling. To boost the heating effect, the upper heater is activated as well. This combination is used for grilling a smaller amount of open sandwiches, meat or beer sausages, and for toasting bread.	240
	GRILL WITH FAN Grill heater and the fan will operate. This combination is used to grill meat and to roast larger chunks of meat or poultry at a single height level. It is also appropriate for dishes au gratin and for browning to a crispy crust.	170
	HOT AIR AND BOTTOM HEATER The bottom heater, the round heater, and the hot air fan will operate. This is used to bake pizza, moist pastry, fruitcakes, leavened dough and shortcrust on several levels simultaneously.	200

SYSTEM	SYSTEM	SUGGESTED TEMPERATURE °C
	HOT AIR Round heater and the fan will operate. The fan installed in the back wall of the oven cavity makes sure the hot air constantly circulates around the roast or pastry. This mode is used for roasting meat and baking pastry at several levels simultaneously.	180
	BOTTOM HEATER AND FAN This is used for baking leavened but low-rising pastry and for preserving fruit and vegetables.	180
	PLATE WARMER Use this function to reheat your dinnerware (plates, cups) before serving food in it to keep the food warm longer.	60
	ECO COOKING ¹⁾ In this mode, power consumption during the cooking process is optimized. This mode is used for roasting meat and baking pastry.	180
	DEFROSTING The air circulates with no heaters activated. Only the fan will be activated. This is used to slowly thaw frozen food. Automatic programs also allow defrosting with microwaves (A1 to A5).	-
	PYROLYSIS This function allows automatic cleaning of the oven cavity/interior using high temperature (approx. 460 °C, which incinerates the fat residues and other impurities, reducing them to ashes.	-

¹⁾ It is used for determining the energy efficiency class pursuant to the EN 60350-1 standard.

Each cooking system features basic or default settings which can be adjusted.

Adjust the settings by pressing the relevant key (before pressing the START/STOP key). Some settings are not available with some programs; an acoustic signal will remind you of such cases.

STEP 2: CHOOSING THE SETTINGS

CHANGING THE COOKING TEMPERATURE

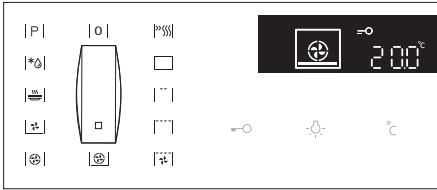

1 Select the COOKING SYSTEM. Selected icon will appear on the display and PRESET TEMPERATURE will flash.

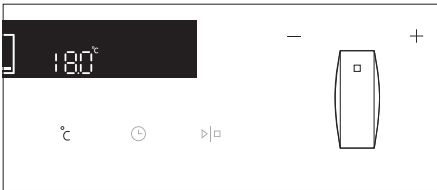

2 Touch the TEMPERATURE KEY. Rotate the SETTINGS KNOB (-/+) and choose the desired temperature.



Maximum temperature is limited with some systems.

When the appliance is switched on with the START key, the symbol °C flashes on the display until the desired value is reached.

STEP 3: TIMER FUNCTIONS

First rotate the COOKING SYSTEM SELECTOR KNOB; then, set the temperature.

Touch the TIMER key several times to select the symbol.

The icon for the selected timer function will light up and the adjustable cooking start/end time will flash on the display. Other icons are dimly lit.

Press START to start the cooking process. ELAPSED COOKING TIME will be displayed.

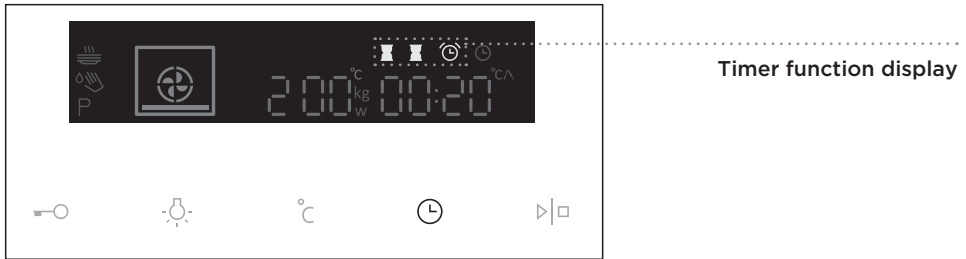

Timer function display



Setting the cooking time

In this mode, you can define the duration of oven operation (cooking time). Set the desired cooking time. First set the minutes, then the hours. Icon and cooking time are displayed on the display unit.



Setting the delayed start

In this mode, you may specify the duration of the cooking process (cooking time) and the time when you wish the cooking process to stop (end time). Make sure the clock is accurately set to current time.

Example:

Current time: noon

Cooking time: 2 hours

End of cooking: 6 pm

First, set the cooking time (cooking duration), i.e. 2 hours. The sum of the current time and cooking time is automatically displayed (2 pm). Touch the TIMER key again to select the COOKING TIME symbol and set the time when you wish the cooking to end (6 pm). Press START to start the cooking process. The timer will wait for the time to start the cooking process and the symbol will be lit up. The oven automatically switches on (at 4 pm) and stops operating and the selected time (at 6 pm).



Setting the minute minder

The minute minder can be used independently of the oven operation. The longest possible setting is 24 hours.

During the last minute, the minute minder is displayed in seconds.



After the set time expires, the oven will automatically stop operating (end of cooking). An acoustic signal will be heard which you may turn off by touching any key. After one minute, the acoustic signal will be switched off automatically.

All timer functions can be cancelled by setting the time to "0".

After a few minutes of idling, the appliance will switch to standby mode.

STEP 4: SELECTING ADDITIONAL FUNCTIONS

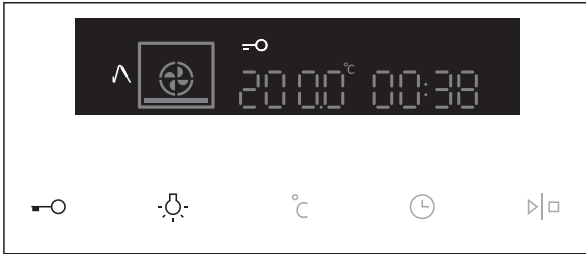

Activate/deactivate the functions by pressing the desired key or a combination of keys.

 Some functions are not available with some systems; an acoustic signal will indicate of such cases.

CHILD LOCK

Activate it by touching the CHILD LOCK key. The "key" icon will light up on the display. Touch the key again to deactivate the child lock. The icon on the display will disappear.

If the child lock is activated with no timer function engaged (only clock is displayed), then the oven will not operate.

If the child lock is activated after a timer function has been set, then the oven will operate normally; however, it will not be possible to change the settings.

When the child lock is activated, systems (cooking modes) or additional functions cannot be changed. The only possible change is to end the cooking process by rotating the selector knob to "0". Child lock will remain active after the oven is switched off. To select a new system, the child lock must first be deactivated.

OVEN LIGHTING

Oven lighting is switched on automatically when the door is opened or when the oven is switched on.

After the end of the cooking process, the light will remain on for another minute.

The light inside the oven can be switched on or off by pressing the LIGHT key.

5sek °C **ACOUSTIC SIGNAL**

Loudness of the acoustic signal can be set when no timer function is activated (only the time of day is displayed).

Press the TEMPERATURE/POWER key and hold it for 5 seconds. Two fully lit bars will appear on the display. Rotate the SETTINGS KNOB (-/+) to choose one of the three volume levels (one, two, or three bars). After three seconds, the setting will be automatically stored and the time of day will appear.

5sek **DECREASING THE DISPLAY CONTRAST**

The cooking system selector knob should be on the "0" position. Press the LIGHT key and hold it for 5 seconds. Two fully lit bars will appear on the display. Rotate the SETTINGS KNOB (-/+) to adjust the display dimmer (one, two, or three bars). After three seconds, the setting will be automatically saved.

+ **STANDBY**

Display lighting can be automatically switched off after 10 minutes if it is not used.

Press the KEY + TIMER keys to switch off the display. If a timer function has been activated, then "OFF" and the TIMER icon will appear on the display to indicate the activated function.



After a power outage or after the appliance is switched off, the additional function settings will remain stored for no more than a few minutes. Then, all settings, except for the acoustic signal and child lock will be reset to factory defaults.

STEP 5: START THE COOKING PROCESS

Start the cooking process by pressing the START/STOP key and holding it for a while.

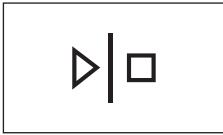

STEP 6: END THE COOKING PROCESS AND SWITCHING OFF THE OVEN

Turn the COOKING SYSTEM SELECTOR KNOB to position "0".

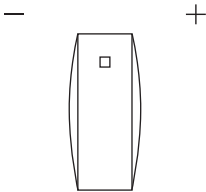

 After the end of the cooking process and after the oven has been switched off, declining temperature is displayed down to 50 °C. All timer settings are also paused and cancelled. Time of day (clock) will be displayed. After one minute of idling, the appliance will switch to standby mode.

DESCRIPTIONS OF SYSTEMS (COOKING MODES) AND COOKING TABLES

If your desired food cannot be found in the cooking table, find information for similar food. The information displayed applies to cooking in a single level.

An interval of suggested temperature is indicated. Start with a lower temperature setting and increase it if you find the food is not browned sufficiently.

Cooking times are rough estimates and may vary subject to some conditions.

Only preheat the oven if required by the recipe of in the tables in this instruction manual. Heating an empty oven consumes a lot of energy. Hence, baking several types of pastry or several pizzas successively will save a lot of energy as the oven will already have been preheated.

Use dark, black silicon-layered or enamel-coated baking sheets and trays as they conduct the heat very well.

When using parchment paper, make sure it is resistant to high temperatures.

When cooking larger chunks of meat or pastry, a lot of steam will be generated inside the oven, which in turn may condense on the oven door. This is a normal phenomenon which will not affect the operation of the appliance. After the cooking process, wipe the door and the door glass dry.

Switch off the oven approximately 10 minutes before the end of the cooking process to save energy by making use of the accumulated heat.

Do not cool the food in a closed oven to prevent condensation (dew).



The asterisk (*) in the table means the oven should be preheated with the selected system.

COOKING SYSTEMS

RAPID PREHEATING



Use this function to heat the oven to the desired temperature as quickly as possible. This mode is not appropriate for cooking.

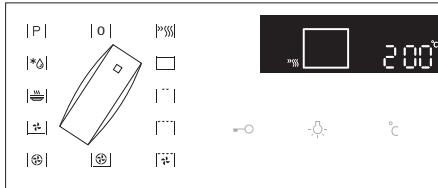

Turn the COOKING SYSTEM SELECTOR KNOB to rapid preheating. PRESET TEMPERATURE will be displayed. This temperature setting can be adjusted.

 When it is switched on, the oven will begin to heat up. The symbol °C will flash on the display. When the set temperature is reached, preheating is completed and an acoustic signal will be sounded. The acoustic signal can be stopped by pressing any key; after one minute, it will stop automatically.

UPPER AND BOTTOM HEATER

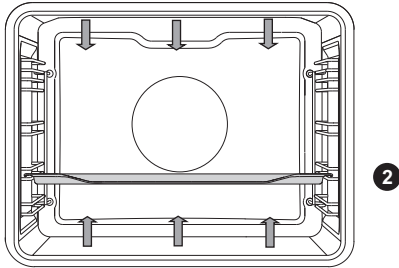

The heaters in the bottom and in the ceiling of the oven cavity will radiate heat evenly into the oven interior.

Roasting meat:

Use enamel coated, tempered glass, clay, or cast iron pan or tray. Stainless steel trays are not suitable as they strongly reflect the heat.

Use enamel coated, tempered glass, clay, or cast iron pan or tray. Stainless steel trays are not suitable as they strongly reflect the heat.

Food	Weight (g)	Guide (from the bottom)	Temperature (°C)	Cooking time (minutes)
MEAT				
Pork roast	1500	2	190-200	120-130
Pork shoulder	1500	2	190-200	120-140
Pork roulade	1500	2	190-200	120-140
Meat loaf	1500	2	200-210	60-70
Beef roast	1500	2	190-210	120-140
Roast beef, well done	1000	2	200-210	40-60
Veal roulade	1500	2	180-200	90-120
Lamb sirloin	1500	2	190-200	100-120
Rabbit loin	1500	2	190-200	100-120
Deer shank	1500	2	190-200	100-120
FISH				
Braised fish	1000	2	210	50-60

Baking pastry

Only use one level and dark baking sheets or trays. In light-coloured baking sheets or trays, the browning of the pastry will be poorer, as such equipment will reflect the heat. Always place the baking trays on the grid. If you are using the supplied baking sheet, remove the grid. Cooking time will be shorter if the oven is preheated.

Food	Guide (from the bottom)	Temperature (°C)	Cooking time (minutes)
PASTRY			
Vegetable soufflé	2	190-200	30-35
Sweet soufflé	2	190-200	30-35
Rolls *	2	200-220	30-40
Bread *	2	180-190	50-60
White bread *	3	180-190	45-55
Buckwheat bread *	3	180-190	45-55
Whole grain bread *	3	180-190	45-55
Rye bread *	3	180-190	45-55
Spelt bread *	3	180-190	45-55
Walnut cake	2	180	55-60
Sponge cake *	3	160-170	25-30
Cheesecake	2	170-180	65-75
Cupcakes	3	170-180	25-30
Small pastries made with yeast dough	3	200-210	25-30
Cabbage pirozhki *	3	185-195	25-40
Fruitcake	3	160-170	40-50
Meringue cookies	3	120	90
Jelly-filled rolls (Buchtel)	2	170-180	30-35

Tip	Use
Is the cake done?	<ul style="list-style-type: none"> • Pierce the cake at the top with a wooden toothpick or skewer. If there are no traces on the pick or the skewer when pulled out, the cake is done.
Did the cake collapse?	<ul style="list-style-type: none"> • Check the recipe. • Next time, use less liquid. • Note the mixing time when using small mixers, blenders etc.
The cake is too light at the bottom?	<ul style="list-style-type: none"> • Use a dark-coloured baking sheet or tray. • Place the baking sheet one guide lower and switch on the lower heater towards the end of the cooking progress.
Cake with moist stuffing is underdone?	<ul style="list-style-type: none"> • Increase temperature and extend baking time.



Do not insert the deep baking tray into the first guide.

LARGE GRILL, GRILL

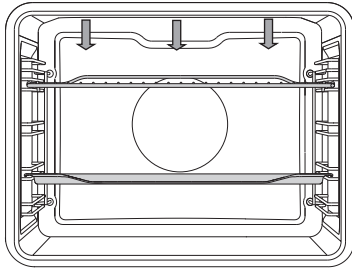

4

2

When grilling food with the large grill, the upper heater and the grill heater fitted on the ceiling of the oven cavity will operate.

When grilling food, the upper heater and the grill heater fitted on the ceiling of the oven cavity will operate.

Preheat the infrared (grill) heater for five minutes.

Supervise the cooking process at all times. The meat may burn quickly due to high temperature.

Roasting with the grill heater is suitable for crispy and low-fat cooking of bratwurst, cuts of meat and fish (steaks, escalopes, salmon steaks or fillets etc.) or toasted bread.

When grilling directly on the grid, smear it with oil to prevent the meat from sticking onto it and insert it into the 4th guide. Insert the drip tray in to the 1st or 2nd guide. When grilling in a baking tray, make sure there is enough liquid in the tray to prevent burning. Turn the meat during cooking.

After grilling, clean the oven, the accessories, and the utensils.

Grilling table - small grill

Type of food	Weight (g)	Guide (from the bottom)	Temperature (°C)	Cooking time (minutes)
MEAT				
Beefsteak, rare	180 g / piece	4	240	18-21
Pork neck fillet	180 g / piece	4	240	18-22
Cutlets/chops	180 g / piece	4	240	20-22
Grill sausages	100 g / piece	4	240	11-14
TOASTED BREAD				
Toast	/	4	240	3-4
Open sandwiches	/	4	240	5-7

Grilling table - large grill

Type of food	Weight (g)	Guide (from the bottom)	Temperature (°C)	Cooking time (minutes)
MEAT				
Beefsteak, rare	180 g / piece	4	240	14-16
Beefsteak, well done	180 g / piece	4	240	18-21
Pork neck fillet	180 g / piece	4	240	19-23
Cutlets/chops	180 g / piece	4	240	20-24
Veal escalope	180 g / slice	4	240	19-22
Grill sausages	100 g / piece	4	240	11-14
Spam (Leberkäse)	200 g / piece	4	240	9-15
FISH				
Salmon steaks/fillets	600	3	240	19-22
TOASTED BREAD				
6 slices of white bread	/	4	240	1.5-3
4 slices of mixed grain bread	/	4	240	2-3
Open sandwiches	/	4	240	3.5-7

When grilling in a baking tray, make sure there is enough liquid in the tray to prevent burning. Turn the meat during cooking.

When baking trout, pat the fish dry with a paper towel. Season on the inside; coat with oil on the outside and place on the grid. Do not turn the fish when grilling.



Always keep the oven door closed when using the grill (infrared) heater.

Grill heater, grid, and other oven accessories get very hot during grilling. Therefore, use oven mitts and meat tongs.

GRILL WITH FAN

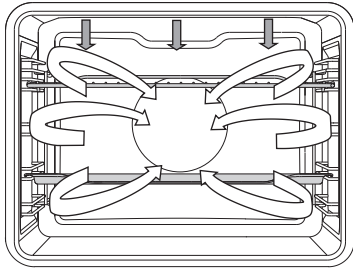

In this operating mode, the grill heater and the fan operate simultaneously. Suitable for grilling meat, fish, and vegetables.

(See descriptions and tips for GRILL.)

Food	Weight (g)	Guide (from the bottom)	Temperature	Cooking time (minutes)
MEAT				
Duck *	2000	2	150-170	80-100
Pork roast	1500	2	160-170	60-85
Pork shoulder	1500	2	150-160	120-160
Pork shank	1000	2	150-160	120-140
Half of chicken	600	2	180-190	25 (one side) 20 (the other side)
Chicken	1500	2	210	60-65
FISH				
Trout*	200 g/kom	2	170-180	45-50

HOT AIR AND BOTTOM HEATER

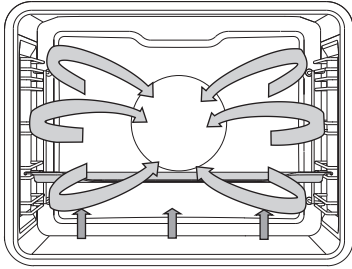

The bottom heater, the round heater, and the hot air fan will operate. Suitable for baking pizzas, apple pies, and fruitcakes.

2 (See descriptions and tips for UPPER and BOTTOM HEATER.)

Food	Guide (from the bottom)	Temperature (°C)	Cooking time (minutes)
Cheesecake, short crust	2	150-160	65-80
Pizza *	2	200-210	15-20
Quiche Lorraine, shortcrust	2	180-200	35-40
Apple pie, leavened dough	2	150-160	35-40
Apple strudel, phyllo dough	2	170-180	45-65

Roasting with a meat probe (depending on the model)

In this mode, set the desired temperature of the food core. The oven operates until the food core reaches the set temperature. Temperature core is measured by the temperature probe.

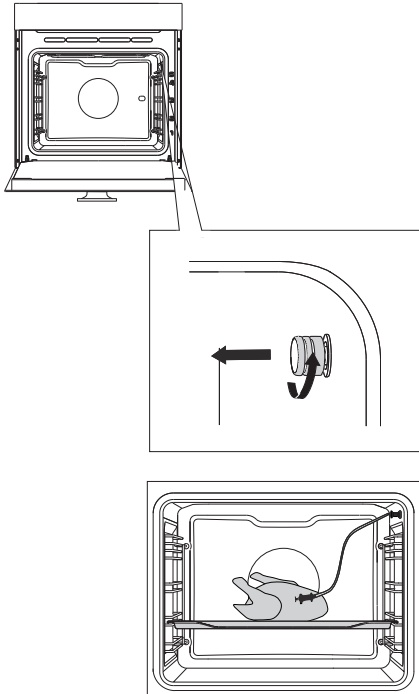

1 Remove the metal cap (the socket is in the front upper corner of the oven right wall).

2 Connect the meat probe plug to the socket and stick the probe into the food. (If any timer settings were activated, they will be cancelled.)

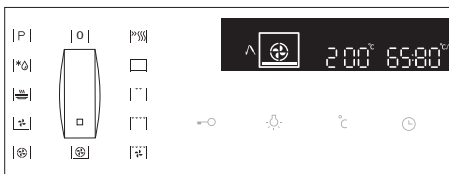

3 Turn the COOKING SYSTEM SELECTOR KNOB (hot air and lower heater). Symbol, preset temperature, probe temperature, and set temperature will appear on the display. Press the START key.



During the cooking process, the display will alternate between current and set temperature in the oven. The temperature may be adjusted during operation. When the set core temperature is reached, the cooking process will stop. An acoustic signal will be heard which you may turn off by touching any key. After one minute, the acoustic signal will be switched off automatically. Clock will appear on the display.

After the cooking process, replace the protective cap of the meat probe socket.



**Only use the probe intended for use with your oven.
Make sure the probe does not touch the heater during cooking.
After the cooking process, the probe will be very hot. Take care
to prevent burning.**

HOT AIR

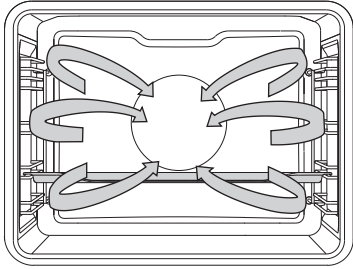

Round heater and the fan will operate. The fan installed in the back wall of the oven cavity makes sure the hot air constantly circulates around the roast or pastry.

Roasting meat:

Use enamel coated, tempered glass, clay, or cast iron pan or tray. Stainless steel trays are not suitable as they strongly reflect the heat.

Provide enough liquid during the cooking process to prevent the meat from burning. Turn the meat during roasting. The roast will remain juicier if you cover it.

Food	Weight (g)	Guide (from the bottom)	Temperature (°C)	Cooking time (minutes)
MEAT				
Pork roast, including skin	1500	2	170-180	140-160
Pork belly	1500	2	170-180	120-150
Chicken, whole	1200	2	180-190	60-80
Duck	1700	2	160-170	120-150
Goose	4000	2	150-160	180-200
Turkey	5000	2	150-170	180-220
Chicken breast	1000	2	180-190	70-85
Stuffed chicken	1500	2	170-180	100-120

Baking pastry

Preheating is recommended.

Biscuits and cookies can be baked in shallow baking sheets on several levels simultaneously (2nd and 3rd).

Note that baking time can differ even with if the baking sheets used are the same. The biscuits in the upper baking sheet may be ready sooner than those in the lower one.

Always place the baking trays on the grid. If you are using the supplied baking sheet, remove the grid.

For even browning, make sure the biscuits are of the same thickness.

Food	Guide (from the bottom)	Temperature (°C)	Cooking time (minutes)
PASTRY			
Cake	2	150-160	45-60
Sponge cake	2	150-160	25-35
Crumble cake	2	160-170	25-35
Fruit cake, sponge	2	150-160	45-65
Plum cake	2	150-160	30-40
Sponge roll*	2	160-170	15-25
Fruit cake, short crust	2	160-170	50-70
Challah (braided yeast bun)	2	160-170	35-50
Apple strudel	2	170-180	40-60
Pizza *	2	190-210	25-45
Biscuits, short crust *	3	150-160	15-25
Biscuits, pressed *	3	150-160	15-28
Cookies, leavened	3	170-180	20-35
Cookies, phyllo dough	3	170-180	20-30
Cream-filled pastry	3	180-190	25-45
PASTRY – FROZEN			
Apple and cottage cheese strudel	3	170-180	50-70
Cheesecake	3	160-170	65-85
Pizza	3	170-180	20-30
Fried potatoes, oven-ready *	3	170-180	20-35
Croquettes, oven-baked	3	170-180	20-35
Yoghurt	3	40	240



Do not insert the deep baking tray into the first guide.



BOTTOM HEATER AND FAN

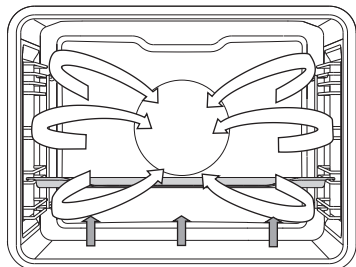

This is used for baking leavened but low-rising pastry and for preserving fruit and vegetables. Use the second guide from the bottom and a rather shallow baking tray to allow the hot air to circulate across the upper side of the dish.

Type of food	Guide (from the bottom)	Temperature	Cooking time (minutes)
FRUIT			
Strawberries	2	180	20-30
Stone fruits	2	180	25-40
Fruit mush	2	180	25-40
VEGETABLES			
Pickled gherkins	2	180	25-40
Beans/carrots	2	180	25-40

PRESERVATION

Prepare the food to be preserved and jars as usual. Use jars with a rubber sealing ring and a glass cover. Do not use jars with threaded or metal caps or metal tins. Make sure the jars are of equal size, filled with the same contents, and tightly sealed.

Pour 1 litre of hot water into the deep tray (approx. 70°C) and place 6 1-litre jars into the tray. Place the tray into the oven on the second guide.

During preservation, observe the food and cook until the liquid in the jars starts to simmer – when bubbles appear in the first jar.

Food	Amount (L)	T = 170 °C - 180 °C until bubbles appear in the jars / until liquid in the jars starts to simmer	Temperature at the start of simmering - when bubbles appeared	Resting time in the oven (min)
FRUIT				
Strawberries	6×1 l	40-55	switch off	25
Stone fruits	6×1 l	40-55	switch off	30
Fruit mush	6×1 l	40-55	switch off	35
VEGETABLES				
Pickled gherkins	6×1 l	40-55	switch off	30
Beans, carrots	6×1 l	40-55	120°C, 60min	30

ECO COOKING

ECO

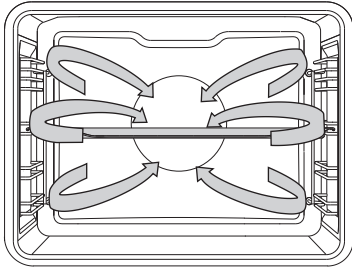

Round heater and the fan will operate. The fan installed in the back wall of the oven cavity makes sure the hot air constantly circulates around the roast or pastry.

Type of food	Guide level (from the bottom)	Temperature (°C)	Cooking time (min)
MEAT			
Pork roast, 1 kg	3	190	140-160
Pork roast, 2 kg	3	190	150-180
Beef roast, 1 kg	3	200	120-140
FISH			
Whole fish, 200 g/piece	3	190	40-50
Fish fillet, 100 g/piece	3	200	25-35
PASTRY			
Pressed cookies	3	170	20-25
Small cupcakes	3	180	25-30
Sponge roll	3	180	15-25
Fruit cake, short crust	3	180	55-65
VEGETABLES			
Potatoes au gratin	3	180	40-50
Lasagne	3	190	40-50
FROZEN FOOD			
Pommes frites, 1 kg	3	210	25-40
Chicken medallions, 0.7 kg	3	210	25-35
Fish sticks, 0.6 kg	3	210	20-30



Do not insert the deep baking tray into the first guide.

DEFROSTING



In this mode, the air will circulate without any heaters operating.

Food suitable for defrosting includes cakes with heavy cream or butter-based cream, cakes and pastry, bread and rolls, and deep-frozen fruit.

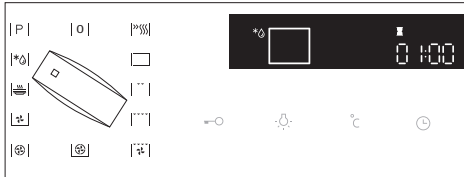

Turn the COOKING SYSTEM SELECTOR KNOB to defrosting. TIME will be displayed. This time setting can be adjusted. Press the START key.

In most cases, it is recommended to remove the food from the packaging (do not forget to remove any metal clamps or clips).

Halfway through the defrost time, the pieces should be turned over, stirred and separated if they were frozen together.

MAINTENANCE & CLEANING



Be sure to unplug the appliance from the power supply and wait for the appliance to cool down.

Children should not clean the appliance or perform maintenance tasks without proper supervision.

Aluminium finish

Clean the aluminium finish with non-abrasive liquid cleaners intended for such surfaces. Apply the cleaner onto a wet cloth and clean the surface. Then, rinse the surface with water. Do not apply the cleaner directly onto the aluminium finish.

Do not use abrasive cleaners or sponges.

Note: The surface should not come into contact with oven cleaning sprays as this may result in visible and permanent damage.

Stainless steel sheet front side of the housing

(depending on the model)

Clean this surface only with a mild detergent (soapsuds) and a soft sponge that will not scratch the finish. Do not use abrasive cleaners or cleaners containing solvents as they may damage the housing finish.

Lacquer-coated surfaces and plastic parts

(depending on the model)

Do not clean the knobs and buttons, door handles, stickers, and rating/type plates with abrasive cleaners or abrasive cleaning materials, alcohol-based cleaners, or with alcohol. Immediately remove any stains with a soft non-abrasive cloth and some water, in order to avoid damaging the surface.

You may also use cleaners and cleaning materials intended for such surfaces as instructed by their respective manufacturers.



The aluminium-coated surfaces should not come into contact with oven cleaning sprays as this may result in visible and permanent damage.

CONVENTIONAL OVEN CLEANING

You may use the standard cleaning procedure to clean stubborn dirt in the oven (using cleaners or an oven spray). After such cleaning, rinse the cleaner residues thoroughly.

Clean the oven and the accessories after each use to prevent the dirt from burning into the surface. The easiest way to remove fat is by using warm soapsuds while the oven is still warm.

With stubborn dirt and grime, use conventional oven cleaners. Rinse the oven thoroughly with clean water to remove all cleaner residue.

Never use aggressive cleaners, abrasive cleaners, abrasive sponges, stain and rust removers etc.

Clean the accessories (baking sheets and trays, grids etc.) with hot water and detergent.

The oven, the oven cavity and the baking trays are lined with a special enamel coating for a smooth and resistant surface. This special coating makes cleaning at room temperature easier.

AUTOMATIC OVEN CLEANING - PYROLYSIS

For average use of the oven, we recommend running the pyrolytic cleaning program once per month to keep the oven cavity clean and free from old grease and dirt.

After the pyrolytic cleaning process, minor discoloration may occur around the door. This can easily be removed with a little soap and a sponge.

Wipe the oven and the accessories to be cleaned in the oven with a damp cloth!

Chunks of food and fat may ignite during the pyrolytic cleaning process. Danger of fire!

Before pyrolytic cleaning wait for the oven to cool down and remove all equipment and accessories from it, including the extendible guides.

*** Depending on the model**

If special-purpose wire guides are supplied with the appliance, mount them in place of the extendible guides before starting the pyrolytic cleaning process.

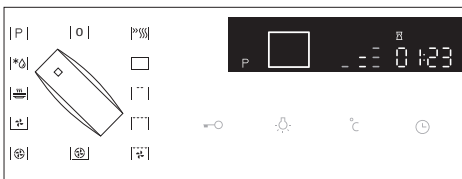

1 Turn the COOKING SYSTEM SELECTOR KNOB to "P".

Cleaning intensity level and time are displayed.

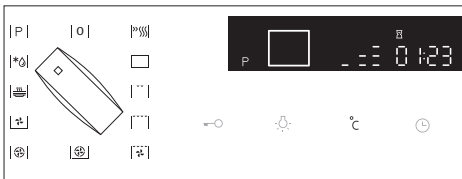

2 Choose the desired cleaning intensity. Touch the TEMPERATURE key and rotate the SETTINGS KNOB (-/+).

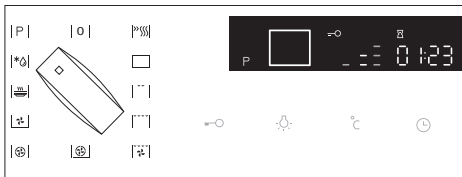

3 After a certain period of time, oven door will be automatically locked for your safety. The key symbol will appear on the display.

 Unpleasant smell may be emitted from the oven during the cleaning process. When the oven has cooled down, wipe it with a damp cloth. Wipe the oven door and the adjacent surfaces in the gasket area. Do not rub the gasket.

CLEANING THE PYROLYTIC ACCESSORIES IN THE OVEN (depending on the model)

The pyrolysis program can also be used to occasionally clean the pyrolytic baking sheets and trays supplied (see Oven accessories). After use, clean them with hot water and detergent, then wipe them with a cloth and place them into the 2nd or 3rd guide. Do not place a baking sheet or tray into the 1st guide. During pyrolytic cleaning, the baking sheets and trays and the oven cavity may partly discolour and lose some shine.

If you also clean baking pans with the pyrolytic cleaning process, then the bottom of the oven may not be entirely cleaned at the end of the process.



Do not attempt to open the oven door while the automatic cleaning program is in progress. The program may be terminated. Risk of burns!

REMOVING AND CLEANING THE WIRE GUIDES

Only use conventional cleaners to clean the guides.

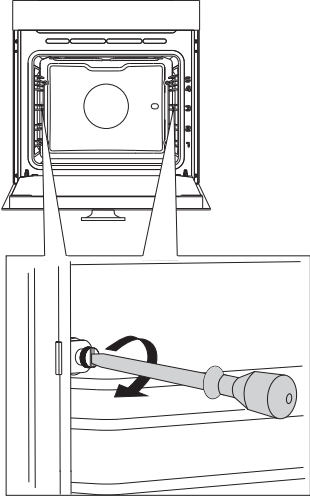

1 Undo the screw.

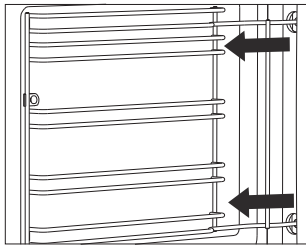

2 Remove the guides from the holes in the back wall.



After cleaning, re-tighten the screws on the guides with a screwdriver.

REMOVING AND INSERTING THE OVEN DOOR

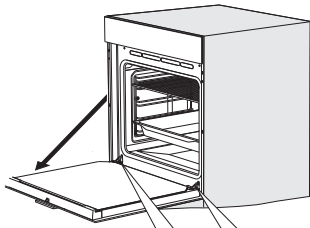

1 First, fully open the door (as far as it will go).

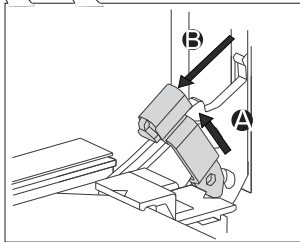

2 Slightly lift the hinge retainers and pull the door towards you.

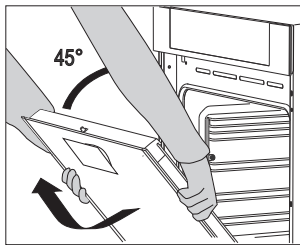

3 Slowly close the door to a 45-degree angle (relative to the position of the fully closed door); then, lift the door and pull it out.



To replace the door, observe the reverse order. If the door does not open or close properly, make sure the notches on the hinges are aligned with the hinge beds.



When replacing the door, always make sure the hinge retainers are correctly placed in the hinge beds to prevent sudden closing of the main hinge which is connected to a strong main spring. If the main spring is engaged, there is a risk of injury.

SOFT DOOR CLOSING (depending on the model)

Oven door is fitted with a system that dampens the door opening force, starting at the 75-degree angle.

SOFT DOOR CLOSING (depending on the model)

Oven door is fitted with a system that dampens the door closing force, starting at the 75-degree angle. It allows simple, quiet, and smooth closing of the door. A gentle push (to a 15-degree angle relative to the closed door position) is enough for the door to close automatically and softly.



If the force applied to close the door is too strong, the effect of the system is reduced or the system will be bypassed for safety.

MECHANICAL DOOR LOCK (depending on the model)

Open the door lock by gently pushing it to the right with your thumb while simultaneously pulling the door outwards.



When the oven door is closed, the door lock automatically returns to the initial position.

REMOVING AND INSERTING THE OVEN DOOR GLASS PANE

Oven door glass pane can be cleaned from the inside, but it has to be removed first. Remove the oven door (see chapter "Removing and replacing the oven door").

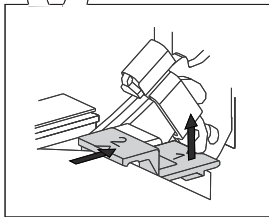
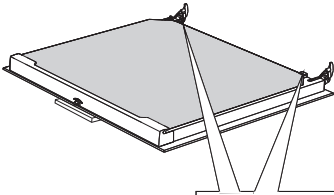

1 Slightly lift the supports on the left and right side of the door (marking 1 on the support) and pull them away from the glass pane (marking 2 on the support).

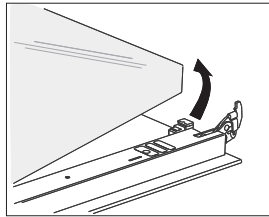

2 Hold the door glass pane by the lower edge; slightly lift it so that it is no longer attached to the support; and remove it.

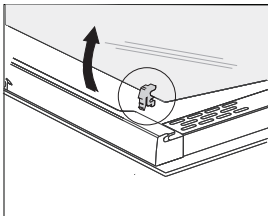

3 To remove the third glass pane (only with some models), lift and remove it. Also remove the rubber seals on the glass pane.

 To replace the glass pane, observe the reverse order. The markings (semicircle) on the door and the glass pane should overlap.

REPLACING THE BULB

The bulb is a consumable and therefore not covered by warranty. Before changing the bulb, remove the trays, the grid, and the guides.

Use a Phillips (cross) screwdriver.
(Halogen lamp: G9, 230 V, 25 W)

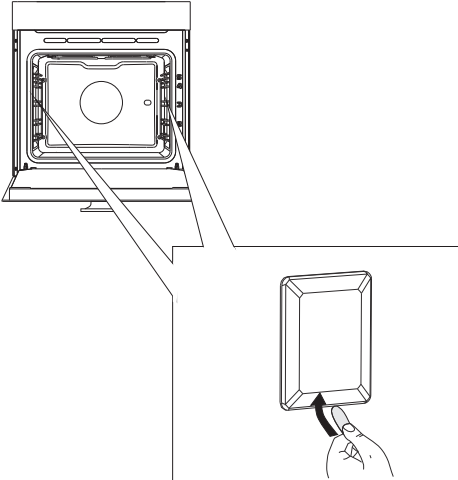

- 1** Use a flat screwdriver to release the bulb cover and remove it.

NOTE: Make sure not to damage the enamel.

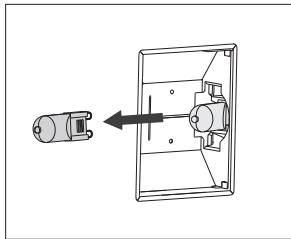

- 2** Remove the halogen bulb.



Use protection to avoid burns.

TROUBLESHOOTING TABLE

Problem/error	Cause
There is no response of the sensors; the display is frozen.	Disconnect the appliance from the power mains for a few minutes (undo the fuse or switch off the main switch); then, reconnect the appliance and switch it on.
The main fuse in your home trips often.	Call a service technician.
The oven lighting does not work.	The process of changing the light bulb is described in the chapter
The pastry is underdone.	Cleaning and Maintenance.
An error code is displayed (E1, E2, E3 etc.).	There is an error in the electronic module operation. Disconnect the appliance from the power mains for a few minutes. Then, reconnect it and set the time of day. If the error is still indicated, call a service technician.

If the problems persist despite observing the advice above, call an authorized service technician. Repair or any warranty claim resulting from incorrect connection or use of the appliance shall not be covered by the warranty. In this case, the user will cover the cost of repair.



Before the repair, disconnect the appliance from the power mains (by removing the fuse or by removing the plug from the wall outlet).

DISPOSAL



Packaging is made of environmentally friendly materials that can be recycled, disposed of, or destroyed without any hazard to the environment. To this end, packaging materials are labelled appropriately.

The symbol on the product or its packaging indicates that the product should not be treated as normal household waste. The product should be taken to an authorized collection center for waste electric and electronic equipment processing.









Correct disposal of the product will help prevent any negative effects on the environment and health of people which could occur in case of incorrect product removal. For detailed information on removal and processing of the product, please contact the relevant municipal body in charge of waste management, your waste disposal service, or the store where you bought the product.

We reserve the right to any changes and errors in the instructions for use.

COOKING TEST



Food tested in compliance with the EN 60350-1 standard.

Conventional baking

Dish	Equipment	Guide (from the bottom)	System	Temperature (°C)	Cooking time (minutes)
Cookies – single level*	Shallow enamel-coated baking sheet	3		140	20-35
Cookies – two levels*	Shallow enamel-coated baking sheet	2 and 3		140	20-35
Cookies – three levels	Shallow enamel-coated baking sheet	2, 3, 4		140	20-35
Cupcakes – single level	Shallow enamel-coated baking sheet	3		140	40-55
Cupcakes – two levels	Shallow enamel-coated baking sheet	2 and 3		140	30-45
Cupcakes – three levels	Shallow enamel-coated baking sheet	2, 3, 4		140	30-45
Cake	Round metal mould/ Wire shelf (support grid)	2		160	20-30
Apple pie	Round metal mould/ Wire shelf (support grid)	2		180	40-50

* Preheat for 10 minutes.

Grill

Dish	Equipment	Guide (from the bottom)	System	Temperature (°C)	Cooking time (minutes)
Toast*	Wire shelf/ grid	4		240	0:30 - 2:30
Minced meat patty (pljeskavica)*	Wire shelf (support grid) + shallow baking sheet as drip tray	4		240	15-25

* Preheat for 10 minutes.

MULTI_IL_PIROLIZA_60



en (03-16)